

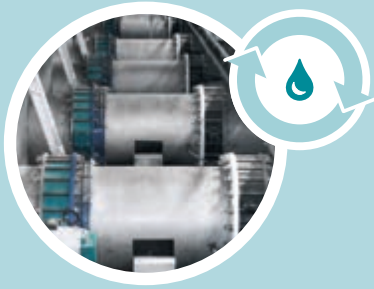

InterApp Product Catalogue

Products for Industrial Applications



Water Treatment



Power Generation



Chemical Process

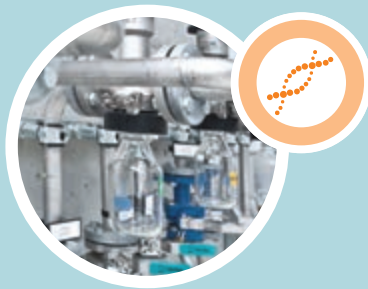

Life Science



HVAC & Swimming Pools

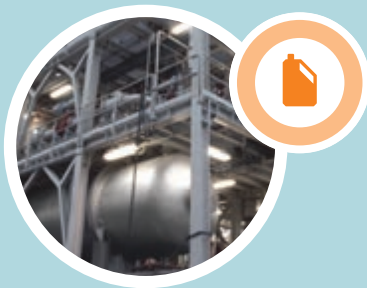

Oil & Gas



Mining & Slurry



Steel Industry

-
- Pulp & Paper
 - Marine
 - Dams & Reservoirs
 - District Cooling & Heating
 - Irrigation
 - Bulk Handling
 - Air Separation

Description

Centric butterfly valve, Fluoroplastic lined for shut-off and control service in aggressive and corrosive fluids and high purity applications. Designed and manufactured in Switzerland for over 20 years.

Product features

- Body construction B1 Wafer DN 32-600
B3 Lug DN 32-400
B4 U-section DN 450-900
- Face to face dimension according to ISO 5752/20, EN 558-1/20
- Top flange according to EN ISO 5211
- Max. working pressure 16 bar (DN32-150)
10 bar (DN200-300)
6 bar (DN350-900)
- Flange connection PN10, PN16, ANSI cl. 150
AS 2129 table D + E and others
- Temperature range -20°C ÷ 200°C according to working conditions, other temperatures on request
- Factory tests Porosity check of the liner and overmoulded disc according to DIN EN 60243-1. Test certificates on request. Tightness test according to EN 12266-1 leakage rate A. The torque of each valve is recorded.

CE

SIL



TA-Luft
FDA and EC 1935/2004

BIANCA butterfly valves meet the safety requirements of the Pressure Equipment Directive 2014/68/EU (PED) appendix 1 for fluids of the groups 1 and 2.

BIANCA Butterfly valves are suitable to be operated in safety related systems according to IEC 61508 / 61511, Safety Integrity Level SIL 3

Special versions of the Bianca valves may be used in potentially explosive atmospheres.

EN ISO 15848 as an available option

The Teflon® used for the Bianca is in compliance with FDA and EC 1935/2004.



CE



B1
Wafer

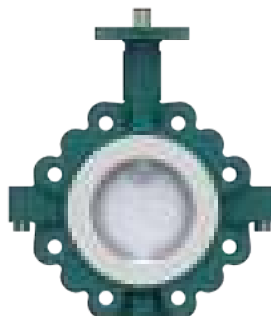

B3
Lug

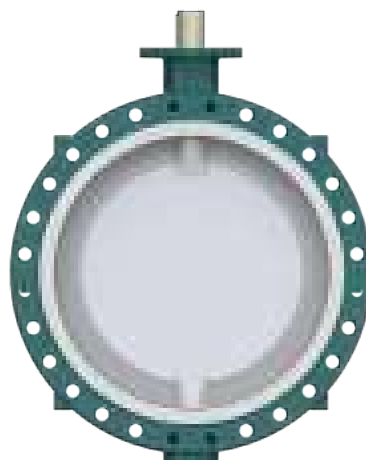

B4
U-section

Construction

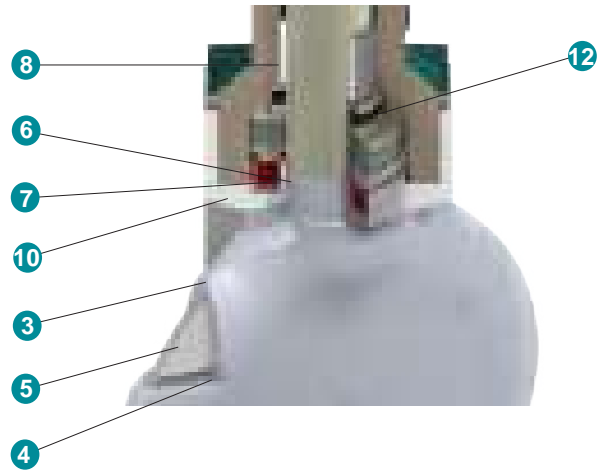
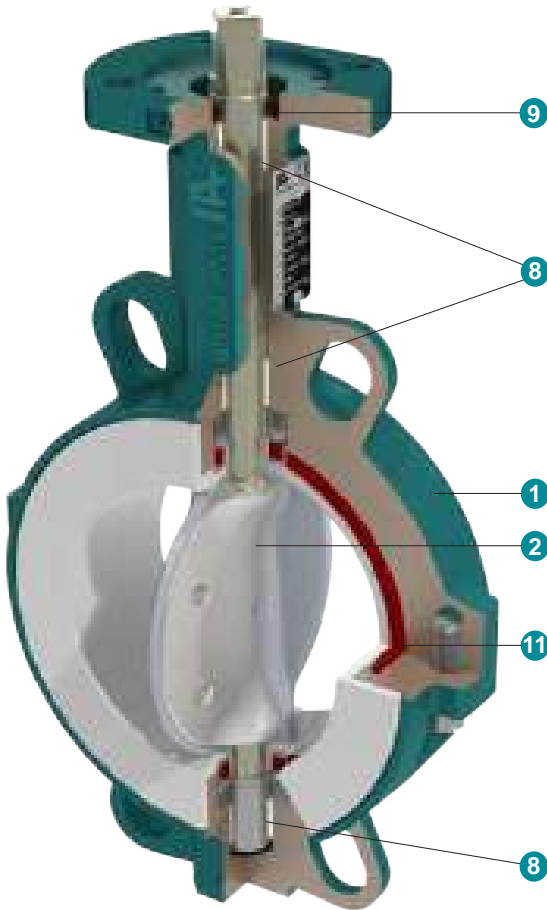

1	Two-piece body in ductile iron EN-JS 1025
2	One-piece, blow out proof disc/shaft
3	Overmoulding with a min. thickness of 3 mm
4	Overmoulding is mechanically locked on the disc
5	Thin core, allows high k_v flow rate
6	Shaft overmoulded in the shaft sealing area
7	Life loaded safety shaft sealing
8	Self-lubricating shaft bushing
9	External shaft seal
10	Chambered liner, prevents radial cold-flow
11	Elastomer backliner, immersed in body
12	TA-Luft VDI 2440 / EN ISO 15848 packing optional

BIANCA HP cleanroom production



Cleansing the parts with ultrapure water



Material lock



Assembly, testing, packaging in clean room class 10'000 / ISO Class 7



Tightness test with ultrapure air

Torques with PTFE liner, safety factor included

DN	32/40	50	65	80	100	125	150	200	250	300	350	400	450	500	600	700	750	800	900
Nm	21	25	39	43	73	87	146	189	330	476	675	900	1100	1300	1750	2100	2500	3100	4000

Kv values m³/h

DN	Opening angle of the valve							
	20°	30°	40°	50°	60°	70°	80°	90°
32/40	4	8	17	30	45	65	85	95
50	5	11	24	42	64	92	118	134
65	8	19	41	70	108	155	200	227
80	15	33	72	125	190	270	335	392
100	20	48	95	162	255	385	485	585
125	38	82	165	255	455	645	815	1015
150	60	130	235	395	645	955	1220	1495
200	95	230	465	795	1180	1815	2410	3050
250	175	350	710	1160	1610	2420	3650	4510
300	265	522	995	1720	2665	3965	5960	7210
350	350	660	1180	1800	2880	4550	7180	8760
400	510	985	1480	2450	4230	6550	9250	11350
450	665	1255	2230	3850	6250	9200	12250	14900
500	890	1620	2980	5350	8150	11800	15560	18000
600	970	2150	4180	7420	11350	16450	21200	24500
700	1060	2560	4868	8412	14359	23901	37638	48633
750	1217	2939	5588	9675	16484	27437	43207	55829
800	1402	3328	6351	11169	19073	32074	51820	63905
900	1915	4259	7897	13849	23887	41112	66771	81016

$$c_v = k_v \cdot 1,16$$

Pressure / temperature diagram

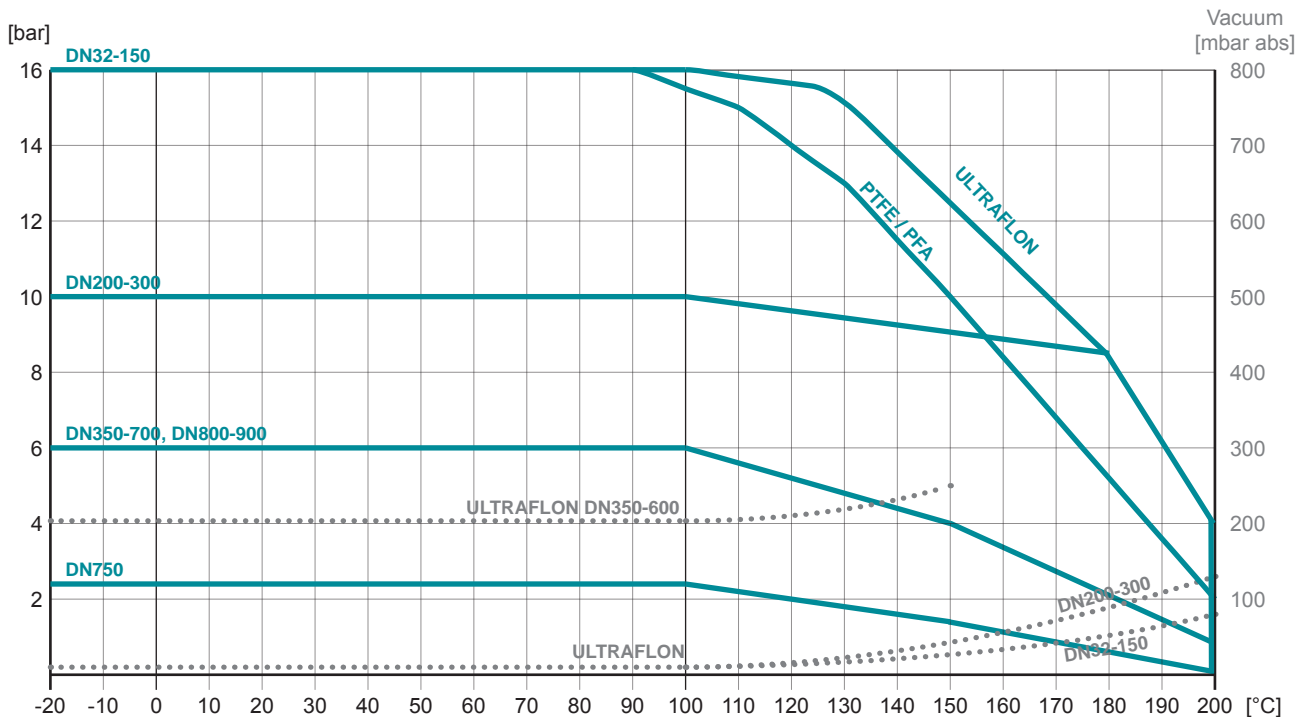

Please consult our technical department for higher temperatures.

Advantage of ULTRAFLO[®] liner

Permeation

Comparison of ULTRAFLO[®] - PTFE - PFA (film thickness 1mm)

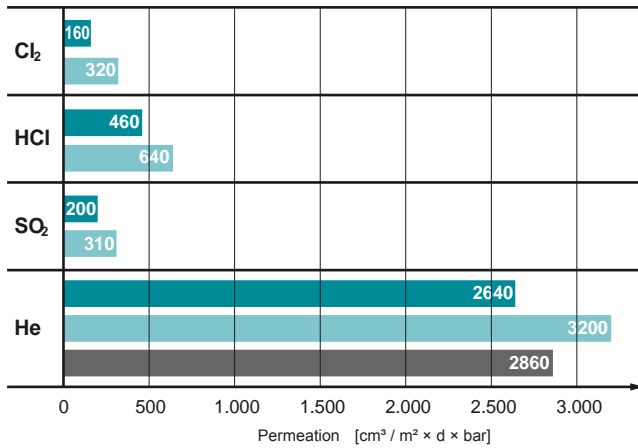

Deformation

Under repeated load „Cold flow behavior“

Loading : 15 N/mm², 4 cycles
 Duration : 100 hours each cycle
 Temperature : 23°C (73°F)
 Perm. deformation after 24 hours recovery

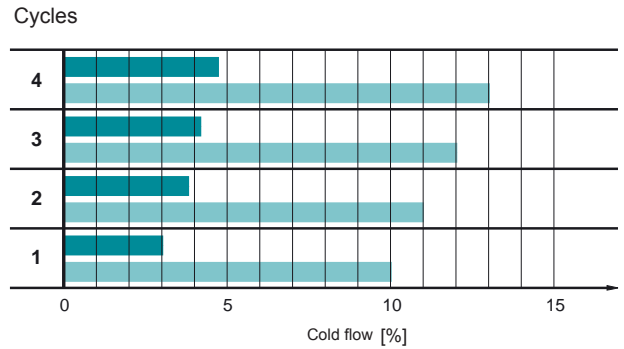

Endurance test (tightness)

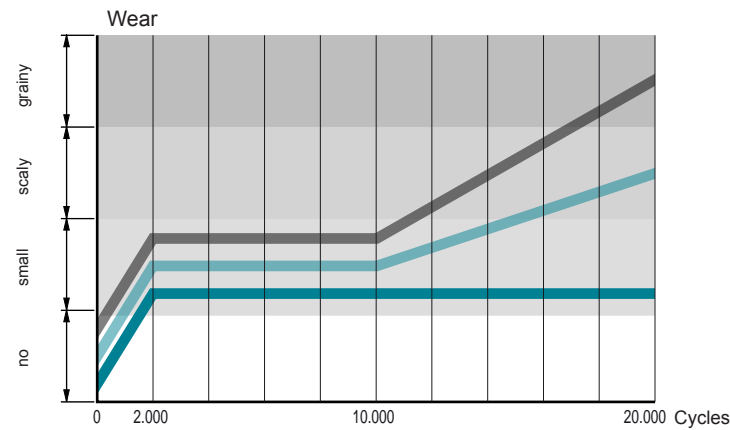
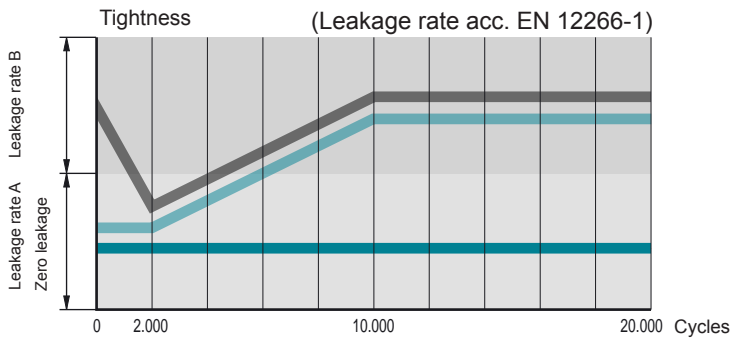

ULTRAFLO[®]
 PTFE
 PFA

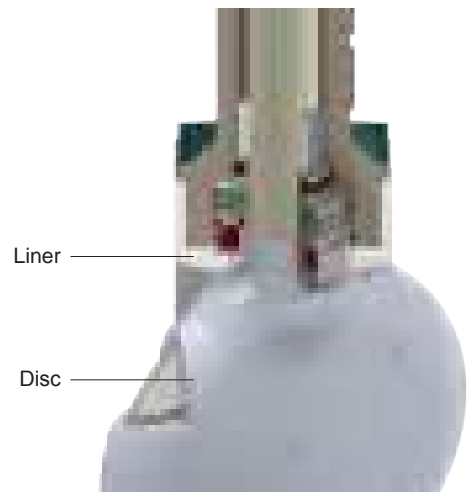



Type code

B1 0100 . 3 3 . 2BE . 4GT . T* E . xx
 ① ② ③ ④ ⑤ ⑥ ⑦ ⑧ ⑨

① Body type	B1	Wafer	DN32-600
	B3	LUG body	DN32-400
	B4	U-section body	DN450-900
② Nominal diameter	0032-0900	mm	
③ Working pressure	0	2,5 bar	DN750, 6 bar with 4LT disc
	1	6 bar	DN350-700, DN800-900
	2	10 bar	DN200-300
	3	16 bar	DN32-150
④ Flange connection	**	PN10/16/ANSI B16.5 cl150 see table below; others on request	
⑤ Body	2BE	Ductile iron EN-JS 1025 / EN-GJS-400-18LT / ≈ ASTM A395 60-40-18, Epoxy coated 80 μm	
	4B0	Stainless steel 1.4409 / ≈ ASTM CF3M	DN32-400
⑥ Disc-shaft, one piece	4G0	Stainless steel 1.4408 / ≈ ASTM CF8M	DN32-300
		Stainless steel 1.4404 / ≈ AISI 316L	DN350-900
	4GP	Stainless steel 1.4408 / ≈ ASTM CF8M polished Ra < 0,8	DN32-300
		Stainless steel 1.4404 / ≈ AISI 316L polished Ra < 0,8	DN350-900
	4GJ	Stainless steel 1.4435 / ≈ AISI 316L, Ferrite < 1%, e-polished Ra < 0,4	DN32-250
	4GT	Stainless steel PFA overmoulded	DN32-300 (>300 on request)
	4LT	Stainless steel PFA overmoulded	DN 750, 6 bar
	3BT	Disc carbon steel PFA overmoulded, shaft stainless steel	DN350-900
	**A	PFA antistatic (no FDA and EC 1935/2004 compliance)	
	4W0	Duplex 1.4469 / ≈ ASTM A 890 grade 5A	DN40-400
	7H0	Hastelloy 2.4819 / ≈ Hastelloy C276	DN50-300 (others on request)
7T0	Titanium 3.7035, Grade 2	(on request)	
⑦ Liner	T*	PTFE (* for elastomer backliner)	
	T*V	ULTRAFYLON® (UF) for vacuum, chlorine or high temperature applications	
	T*A	PTFE antistatic	
	T*VA	ULTRAFYLON® antistatic	
	U*	Ultralene (UHMWPE) for abrasive applications, max. 80 °C	DN 80, 100, 150, 200
⑧ * Elastomer backliner	S	MVQ	
	E	EPDM	
	V	FPM	
⑨ Special execution	LF	Without painting adhesion interfering substance	
	HP	High purity: The valve is cleaned, assembled, tested and packaged under cleanroom conditions. (US federal standard 209b, class 10000, ISO Class 7 (ISO 14644-1))	
	112/246	See corresponding document: InterApp Butterfly Valves for use in potentially explosive atmospheres	
	180	TA-Luft VDI 2440 / EN ISO 15848	

Other options upon request!

**Flange connection (Code)

BIANCA	DN →	32	40	50	65	80	100	125	150	200	250	300	350	400	450	500	600	700	750	800	900		
 B1	PN10							3								2							
	PN16								3														
	ANSI cl.150									3							A						
 B3	PN10					3					2												
	PN16								3														
	ANSI cl.150									A													
 B4	PN10															2						2	
	PN16															3						3	
	ANSI cl.150																A						

When mounting the valve at the end of a line please note:

- Body type Lug B3
- Temperature 10 + 60°C
- Medium only for non-hazardous liquids
- no water hammer !

- Max. working pressure

DN32-150	8 bar
DN200-300	6 bar
DN350-400	4 bar

Dimensions

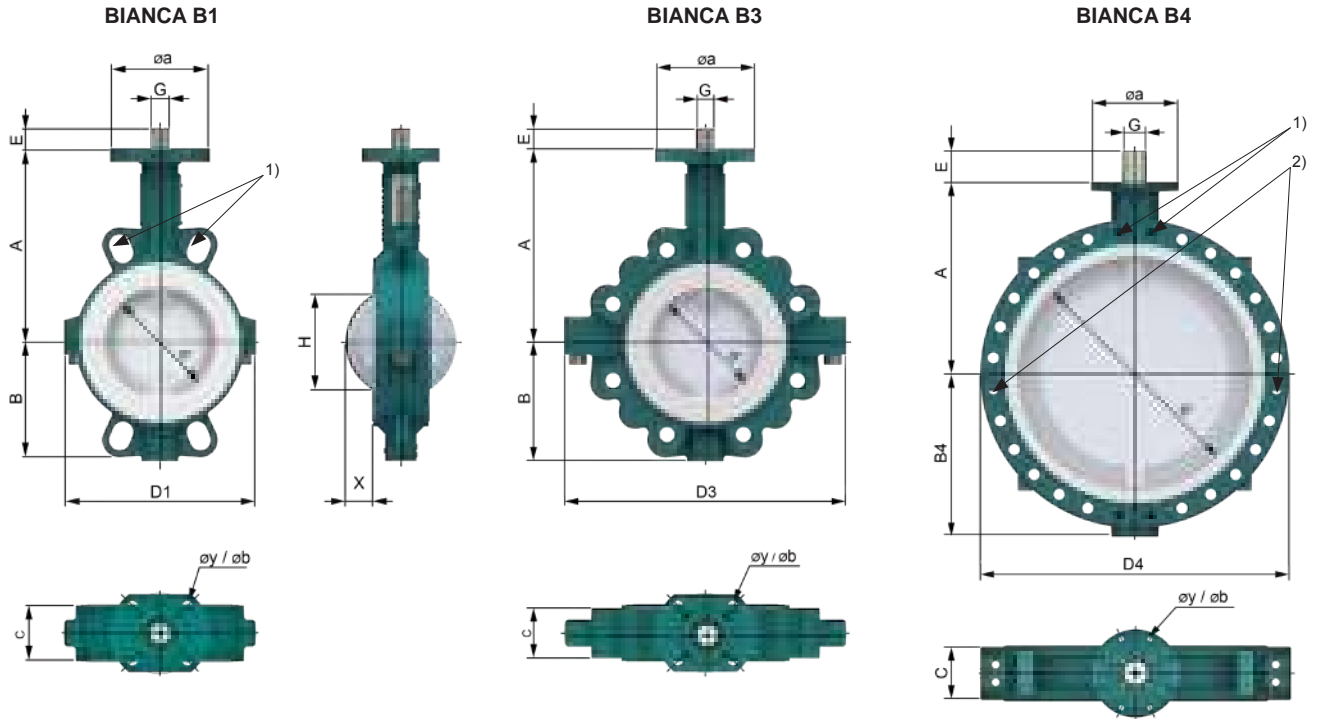

1) DN 450 - 900, 2 x threads on valve neck and bottom
 2) DN 600 - 900, 2 threads on both sides

DN	d	A	B	B4	C	H	X	D1	D3	D4	ISO	a	y	b	G	E	B1[kg]	B3[kg]	B4[kg]
32/40	40	125	69	-	33	23	4	105.8	136	-	F05	65	4x7	50	11	12	1.7	2.4	-
50	50	134	68	-	43	26	9	118.4	162	-	F05	65	4x7	50	11	12	2.3	3.2	-
65	65	145	78	-	46	39	7	132.5	170	-	F05	65	4x7	50	11	12	2.9	4.1	-
80	80	160	92	-	46	66	17	144	216	-	F05	65	4x7	50	11	12	3.4	6.2	-
100	100	175	107	-	52	86	24	173	254	-	F05/07	90	4x7/9	50/70	14	16	5.1	9.3	-
125	125	194	120	-	56	112	35	219	293	-	F05/07	90	4x7/9	50/70	14	16	6.9	10.7	-
150	150	210	134	-	56	140	47	247	315	-	F07	90	4x9	70	17	19	10	12.9	-
200	200	239	162	-	60	191	70	295	389	-	F07/F10	125	4x9/11	70/102	17	19	14.1	22.3	-
250	250	275	199	-	68	241	91	367	483	-	F10	125	4x11	102	22	24	22.9	32.4	-
300	300	310	230	-	78	290	111	419	543	-	F10	125	4x11	102	22	24	32.9	46.9	-
350	339	349	254	-	78	330	131	428	564	-	F12	155	4x 13.5	125	27	40	50	87	-
400	400	379	287	-	102	387	149	473	620	-	F12	155	4x 13.5	125	27	40	68	98	-
450	450	426	320	320	114	436	168	528	-	630	F14	175	4x 18	140	Ø45	65	100	-	140
500	500	451	360	360	127	484	187	588	-	700	F14	175	4x 18	140	Ø45	65	122	-	175
600	600	555	415	415	154	580	223	686	-	820	F16	210	4x 22	165	Ø60	90	180	-	275
700	703	605	-	482	165	684	269	-	-	930	F16	210	4x 22	165	Ø72	80	-	-	423
750	750	629	-	489	190	726	280	-	-	970	F16	210	4x 22	165	Ø60	91	-	-	383
800	803	658	-	550	190	781	307	-	-	1060	F25	300	8x 18	254	Ø80	108	-	-	670
900	900	710	-	602	203	877	349	-	-	1160	F30	350	8x 22	298	Ø98	128	-	-	880

Dimensions X and H are without safety factors!

The customer must define safety distances to allow proper installation of the valve.

Dimensions

Top flange according to ISO 5211

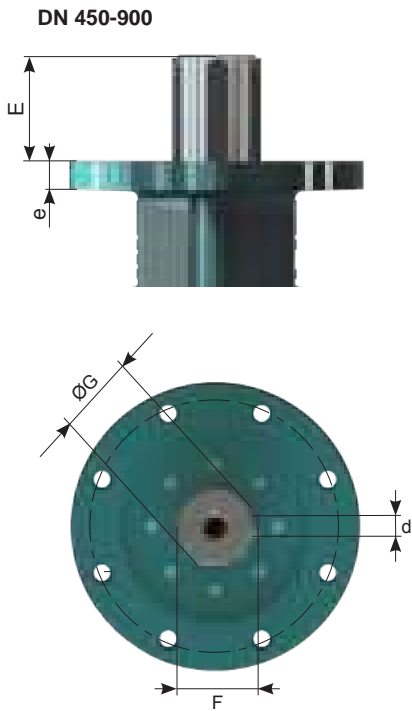

Wafer, Lug and U-section

Size	E	ØG	d	e	F
450	65	45	14	9	48,8
500	65	45	14	9	48,8
600	90	60	18	11	64,4
700	3	72	20	12	76,9
750	91	60	18	11	64,4
800	108	80	22	14	85,4
900	128	98	28	16	104,4

Dimensions

Handlever

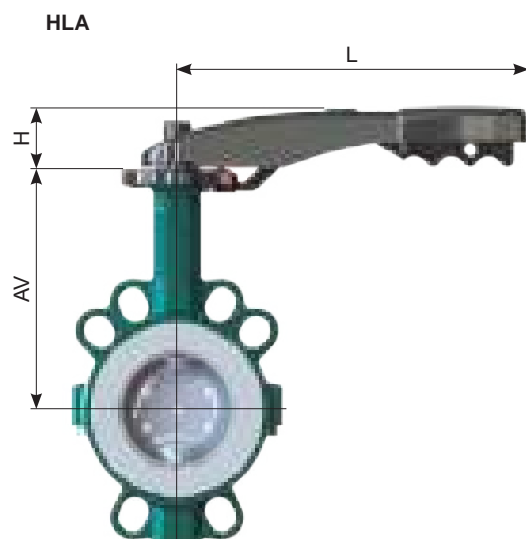

HLA : Aluminum Epoxy coated

DN		AV	H	L	[kg]*
32/40	HLA.F0511.180K	125	41	180	0.4
50	HLA.F0511.240K	134	43	240	0.5
65	HLA.F0511.240K	145	43	240	0.5
80	HLA.F0511.240K	160	43	240	0.5
100	HLA.F0714.340K	175	51	340	0.6
125	HLA.F0714.340K	194	51	340	0.6
150	HLA.F0717.340K	210	51	340	0.6

* [kg] weight without butterfly valve

Dimensions

Gearbox

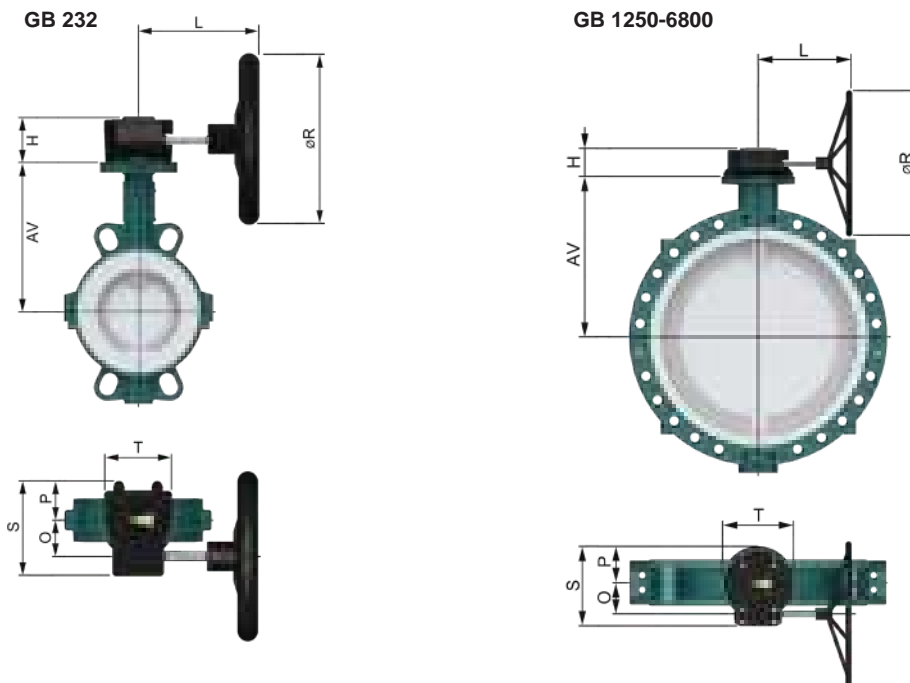

DN		AV	H	L	O	P	R	S	T	n**	[kg]*
32/40	GB232-05.F05-F0711.100	125	53	126	42,5	48	100	114	80	10	0,8
50	GB232-05.F05-F0711.100	134	53	126	42,5	48	100	114	80	10	0,8
65	GB232-05.F05-F0711.100	145	53	126	42,5	48	100	114	80	10	0,8
80	GB232-05.F05-F0711.100	160	53	126	42,5	48	100	114	80	10	0,8
100	GB232-05.F05-F0714.100	175	53	126	42,5	48	100	114	80	10	0,8
125	GB232-05.F05-F0714.100	194	53	126	42,5	48	100	114	80	10	0,8
150	GB232-06.F05-F0717.160	210	59	189	42,5	48	160	114	80	10	0,9
200	GB232-06.F05-F0717.160	239	59	189	42,5	48	160	114	80	10	0,9
250	GB232-08.F07-F1022.250	275	67	219	50	56	250	131	100	9,25	1,55
300	GB232-08.F07-F1022.250	310	67	219	50	56	250	131	100	9,25	1,55
350	GB232-13.F10-F1227.300	349	85	371	80	83	300	209	175	10	5,4
400	GB232-13.F10-F1227.400	379	85	371	80	83	300	209	175	10	5,4
450	GB880N.F1445.500	426	92	305	86	101	500	227	200	9,5	14
500	GB880N.F1445.500	451	92	305	86	101	500	227	200	9,5	14
600	GB1250N.F1660.500	555	102	346	104,5	110	500	258	220	13,75	22
700	GB1950N.F1672.600	605	126	387	130	142,5	600	322,5	285	13	32
750	GB1950N.F1660.700	629	126	387	130	142,5	700	322,5	285	13	32
800	GB2000NLB.F2580.500	658	120	348	53	142	500	300	285	27	27
900	GB6800N/PR4.F3098.400	710	159	470	182	170	400	407,5	370	81,5	63

Material: GB 232 Aluminum, Polyurethane coated
 GB1250-GB6800 GG 25 Polyurethane coated

* [kg] weight without butterfly valve and handwheel

** n = Handwheel turns ON/OFF

Further documentation

Pneumatic actuators, Electric actuators, Accessories please see respective data sheets.

Installation guide, Maintenance guide, Flanges: Please consult these guides for installation and maintenance of our butterfly valves.

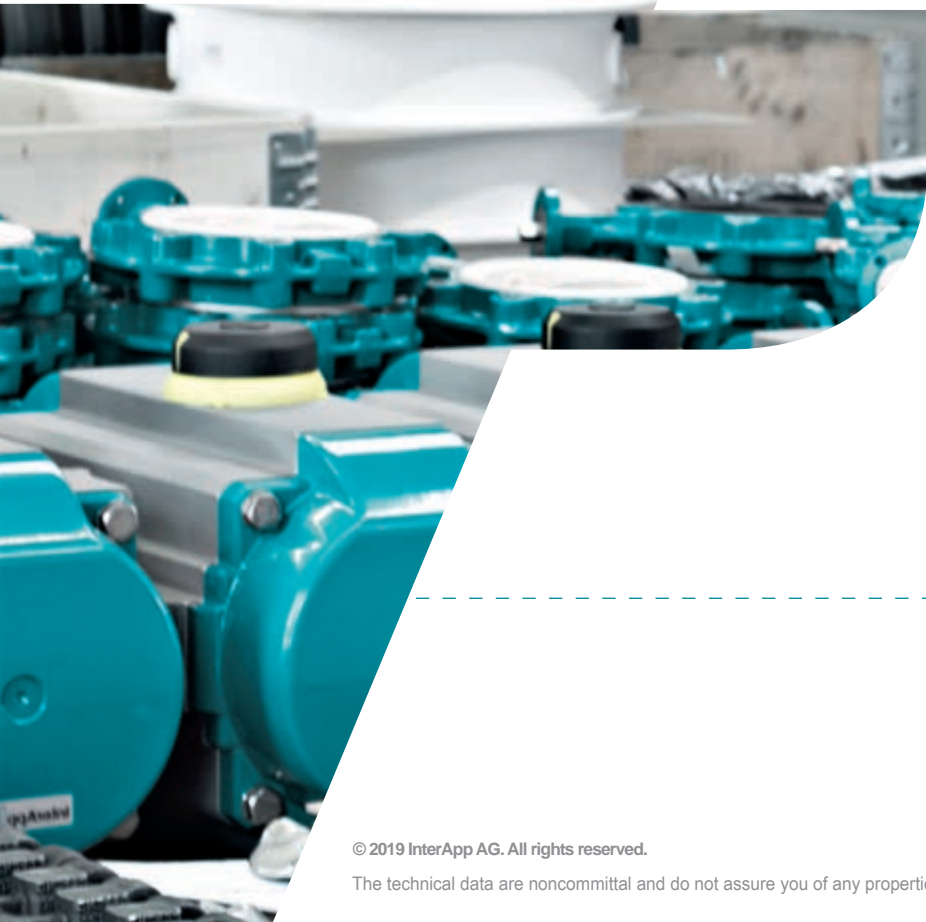
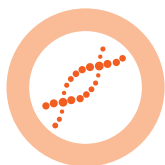

InterApp AG

Grundstrasse 24

CH-6343 Rotkreuz

Phone +41 (0) 41 798 22 33

Fax +41 (0) 41 798 22 34

info@ch.interapp.net

www.interapp.net